

Mirror Reflex Motion Picture Camera

ARRIFLEX 35

Model II C

INSTRUCTION MANUAL

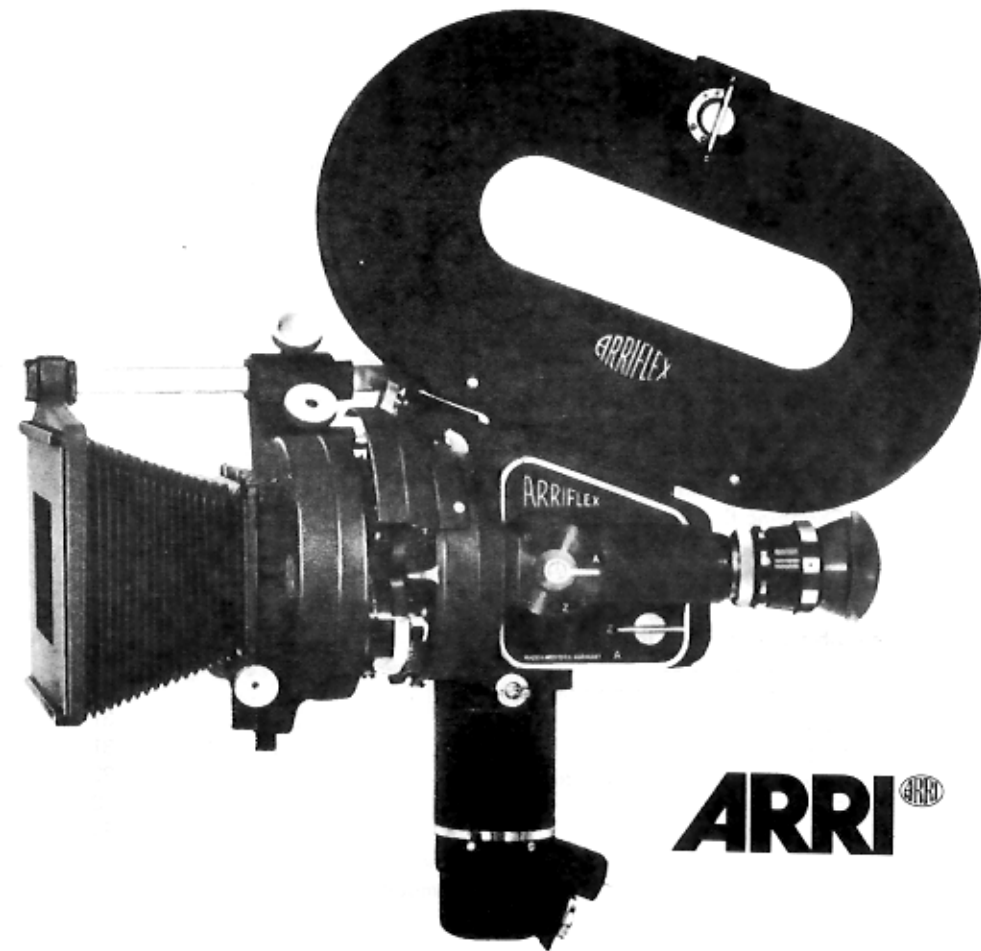

ARRI 

ARRIFLEX CORPORATION

500 ROUTE 303, BLAUVELT, NY 10913 (914) 353-1400
TWX 7105752624 FAX (914) 425-1250
600 N. VICTORY BLVD., BURBANK, CA 91502
(818) 841-7070 TWX 9104984641 FAX (818) 848-4028

ARRI 

TABLE OF CONTENTS

	Page
I. General description of camera	3
Camera housing	3
Three-lens turret	4
Mirror reflex viewfinder system	4
Viewfinder eyepieces	6
Mounting the viewfinder eyepiece on the camera	6
Sunshades, stationary and adjustable	7
Magazines	8
Motors	8
II. Loading the camera	10
Loading of 200 ft (60 m) magazines	10
Film loop guard	14
Mounting the 200 ft (60 m) magazine upon the camera	14
Threading of film in the camera	16
(for the 400 ft (120 m) V-R magazine see special leaflet)	
III. Operation of the camera	17
How to hold the camera	17
Viewfinding and focusing	17
Changing lenses	18
Setting the adjustable shutter	19
(only applies to the special model ARRIFLEX 35 II C-BV)	
Starting the camera	23
Storage and transport of the camera	24
IV. Care and maintenance of the ARRIFLEX 35 II C	25
Changing the ground glass	25
Cleaning	25
Lubrication	27
V. Possible troubles and their correction	30
Unsteady pictures	30
Emulsion deposits at the film gate	30
Scratched film	31
Fogging	31
Lack of brilliance or poor definition	32
Film jamming	33
Irregular running	34
Camera runs too slowly, irregularly, or not at all	34
Film end jams in film gate or magazine mouth	35

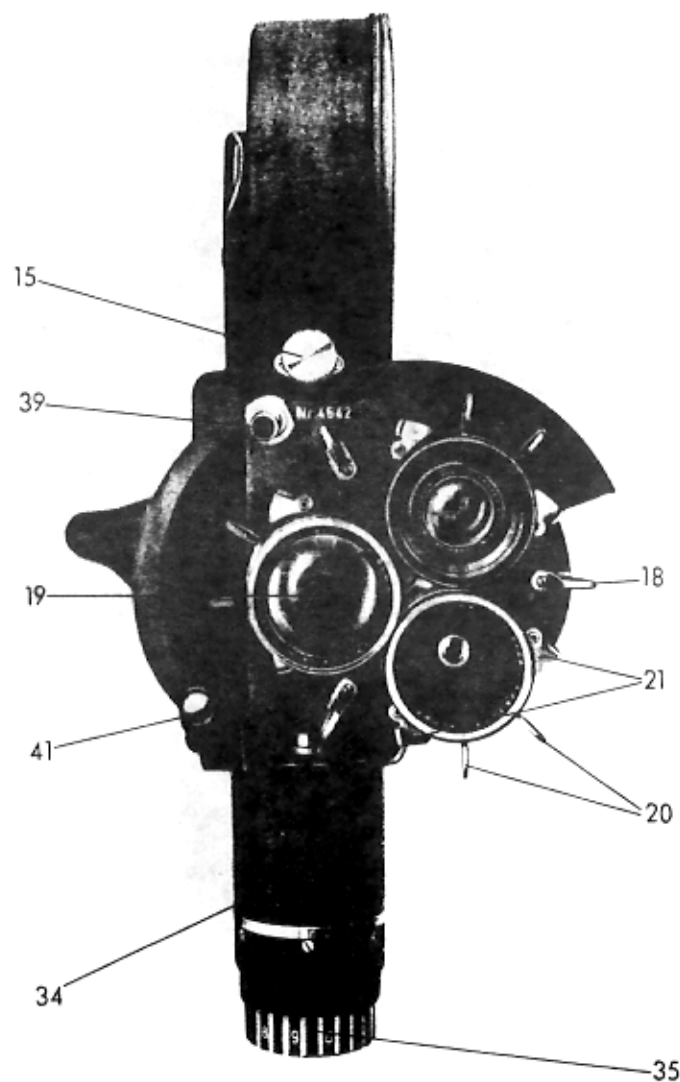

- 15 Magazine lock
- 18 One of three grips for rotating the turret
- 19 Lens in shooting position
- 20 Focusing grip on lens

- 21 Lens locking grips
- 34 Handgrip motor
- 35 Rheostat control cap
- 39 Sunshade mount
- 41 Sunshade bracket

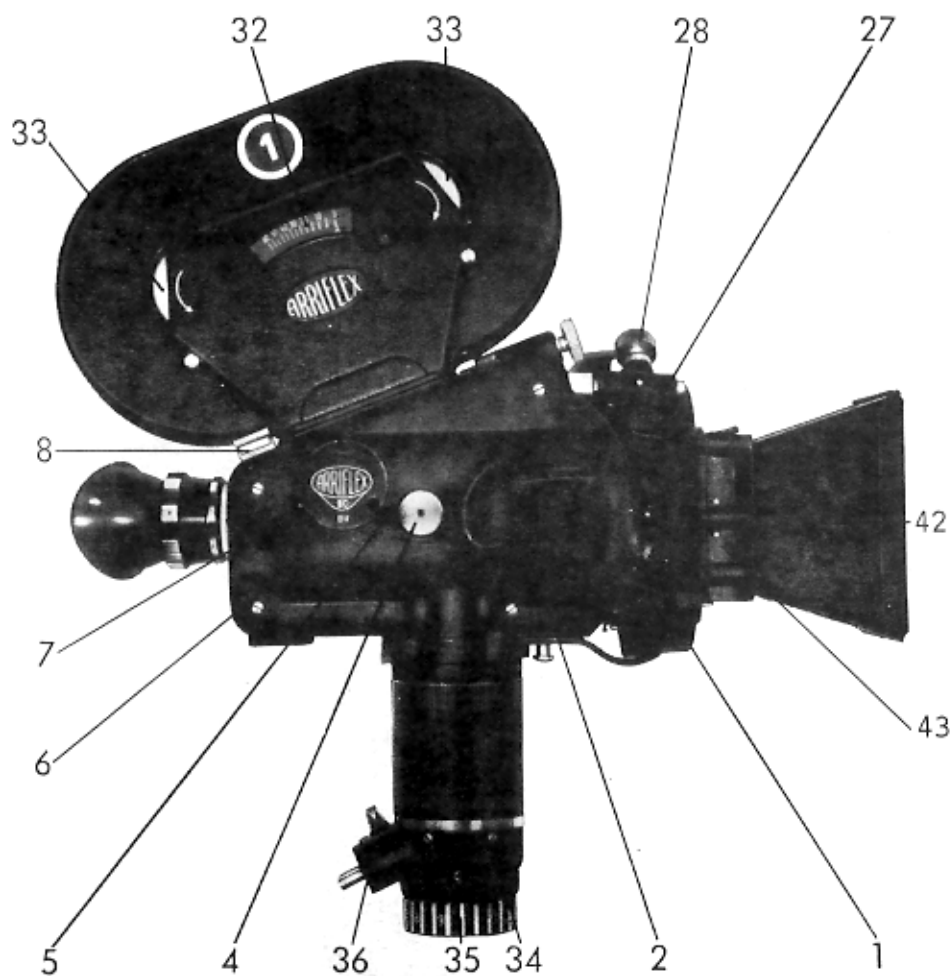

- | | |
|---|---|
| 1 Bulge containing mirror reflex shutter | 27 Clamp |
| 2 Thumb grip | 28 Knurled screw on clamp |
| 4 Manual control knob for rotating the camera mechanism by hand | 32 Footage indicator |
| 5 Projecting guard to 4 | 33 Knurled disks for taking up film slack in magazine |
| 6 Tachometer | 34 Handgrip motor |
| 7 Mounting position for impulse generator of blimp pilot light | 35 Rheostat control cap |
| 8 Eyelet for neck strap | 36 Socket for power cable |
| | 42 Sunshade |
| | 43 Filter holder |

Reverse side: front view of the ARRIFLEX 35 II C

I. General description of camera

For ease of reference the illustrations to this description of the ARRIFLEX 35 II C have been printed on the cover flaps of this manual and can be folded out on either side of the text.

If you open out the covers you will see two side views of the ARRIFLEX 35 II C. Turn the flaps inwards and you will find the front and rear views of the camera on the reverse side. All parts referred to in the text are numbered. With the aid of these numbers you will be able to locate the parts in the illustrations quite easily and thus become quickly acquainted with the most important features of your ARRIFLEX 35 II C.

The ARRIFLEX 35 II C – complete with mirror reflex system, viewfinder, three-lens turret and variable speed handgrip motor – is normally delivered with a 200 ft (60 m) single compartment magazine with a plastic take-up core, a sunshade with filter holder for 3" x 3" (75 x 75 mm) filters, a battery cable, a cutting templet, three dust caps for empty lens sockets, a neck strap, a small bottle of non-freezing oil and a small tin of non-freezing grease. In addition to this, a lens and a battery are required as minimum accessories.

Camera housing

Right side: The bulge **1** containing the mirror reflex shutter and the thumb grip **2** are designed to give the operator a firm grip on the camera. On the ARRIFLEX 35 II model II C-BV, the adjustment knob for the adjustable shutter is located directly beneath the thumb grip. On all ARRIFLEX 35 II C cameras the manual control knob **4** for the manual rotation of the mirror reflex shutter is located behind the thumb grip. Beside this a projecting guard **5** is screwed onto the camera which can be removed for operation of the camera with the synchronous motor and screwed into a safe keeping position near the thumb grip. The tachometer **6** indicates film speeds from 0 to 50 f. p. s. Above the tachometer is a mounting position **7** for the pilot light impulse generator used in blimp operation. This impulse generator is delivered as standard equipment if the ARRIFLEX 35 II C is ordered with a blimp, otherwise it is only available at an extra charge.

The eyelet **8** on the camera housing is for the neck strap. A 3/8" threaded tripod socket is located at the rear underneath the camera.

Left side: The camera door **9** is completely detachable and is secured in position by a lock **10**. The viewfinder tube **11** is built into the camera door. The

tube has a knurled ring at the end for connecting the viewfinder eyepiece 13. The detachable eyecup 12 is mounted so that it can be rotated upon the eyepiece. By means of the diopter adjustment ring, the viewfinder can be adapted to individual eyesight. A light sealing device 14 is built into the detachable camera door between the ground glass and the viewfinder tube. The magazine lock 15 and a second eyelet 16 for the neck strap are located above the three-lens turret.

Three-lens turret

The three-lens turret is designed to take three interchangeable lenses with a mounting diameter of 41 mm. The flange focal distance (from the lens mounting flange to the film surface) is 52 mm. The turret can be rotated easily by means of the three grips 18 until a click stop indicates that the desired lens is in shooting position 19. Code marks engraved on the rear edge of the turret grips enable the lenses to be identified without removing the camera from the eye. Most normal lenses are equipped with large focusing grips 20. To change a lens the two locking grips 21 are pressed together and the lens lifted out.

Mirror reflex viewfinder system

With the 180° rotary mirror shutter the film surface and the ground glass each receive in turn the full intensity of the image projected by the lens. Through the eyepiece, whether the motor is running or still, with open or stopped-down lens, the operator sees a bright 6½ x magnified image upon the ground glass which is extremely free of parallax, identical in sharpness and format with the film image, free of mirror effect and upright. The viewfinder system of the Model II C has been improved to include the entire CinemaScope sound film format (18.67 x 22 mm), thus removing the previous limitation whereby the viewfinder image during anamorphic shots remained at the normal 16 x 22 mm format.

The ground glass can easily be exchanged for one of a different format by the operator without special tools (see part IV of this manual).

For shots with ULTRASCOPE or CinemaScope anamorphic lenses (compression factor 2) the light sealing device 14 can be exchanged for an anamorphic insert. This gives a viewfinder image which is free of distortion and eliminates the need for a separate viewfinder system for anamorphic shots. The mounting of this insert must be done at the factory.

We supply ground glasses with the following markings:

Standard format	1:1.375
TV safe action format	3:4
Wide-screen format	1:1.66
Anamorphic optical sound format	1:2.35
TechniScope II format	1:2.35
Wide-screen format	1:1.85

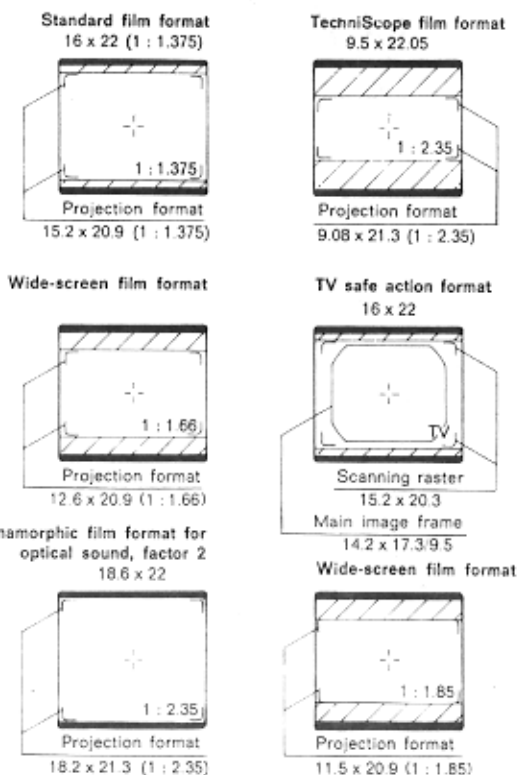

On special request we also supply ground glasses with marking of US Television format.

In addition, customers' special wishes with regard to individual markings such as other formats, crossed hairs, grids, etc. can also be met.

Viewfinder eyepieces

The image carried over by the mirror reflex shutter is seen through the viewfinder eyepiece. This is connected to the viewfinder tube by means of a knurled ring and can be removed by loosening the ring. **The adjustment between the film image and the viewfinder image is not influenced by this.**

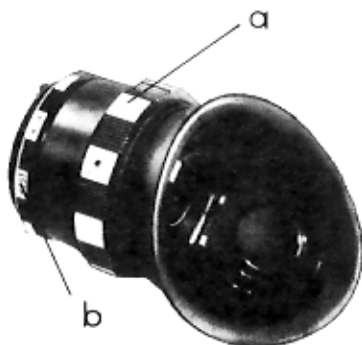

Two different viewfinder eyepieces are available. Both can be adapted to individual eyesight by means of a diopter adjustment ring (a). The adjusted focusing can be held by tightening the knurled locking ring (b). A hinged lens cap protects the film against undesired light entering through the eyepiece. The rubber eyecup is mounted rotating upon the eyepiece and can be detached. The mount of the eyecup has a prepared centering for a corrective lens for the eye of the respective operator (in cases where the diopter adjustment is insufficient or to compensate for astigmatic eye deficiencies). A diopter calibration was left out intentionally.

The viewfinder eyepiece Cat. No. 2009 has an automatic closure mechanism. This opens automatically when the eye is pressed against the eyecup and closes when the eye is taken away. In addition the closure mechanism can be locked at an open position. (The use of this is described in a special leaflet: TI E 01 101).

The universal periscopic viewfinder attachment from the ARRIFLEX 16 can be mounted between the viewfinder tube and the detachable viewfinder eyepiece. (The use of this is described in the operating instructions for the periscope viewfinder attachment). However, because of the larger frame format of 35 mm film, the viewfinder image is cut slightly at the edges.

Mounting the viewfinder eyepiece on the camera

The eyepiece is centered at the end of the viewfinder tube and rotated until both pins on the front side fit into the corresponding holes. Before the eyepiece

is tightened on with the knurled ring one must make certain that the front side of the eyepiece is even with and flat against the viewfinder tube. The knurled ring is then carefully turned without tilting or forcing it. **Notice: The knurled ring has double threads. If it does not turn easily at once, turn it back and try again!** The use of force damages the threads.

Sunshades, stationary and adjustable

A sunshade (Fig. 1) is included in the standard equipment of the ARRIFLEX 35 II C to protect the shooting lens from stray light and to shield the lenses not in use. It also serves as a filter holder.



Fig. 1: A sunshade belongs to the standard equipment of the ARRIFLEX 35 II C. Either this or the practical adjustable sunshade with bellows (available as a special accessory under Cat. No. 2001) should be used for all shots in order to achieve maximum sharpness and contrast.

The adjustable sunshade with bellows **22** is a special accessory. It serves as a sunshade for the lens in use and protects the idle lenses from stray light with its lens cover **23**. It also acts as a filter holder. The adjustable sunshade consists of a collapsible leather bellows **24**, the front frame of which has a ribbed profile for added stability and is attached to a sliding boom **26**. The fully extended position gives the protection required for a lens with a focal length of 50 mm. The front frame of the sunshade also takes special effects masks as well as correspondingly smaller special masks for lenses of longer focal length, i. e. over 50 mm. The sunshade boom slides through a clamp **27** and is held at the required position with a knurled locking screw **28**. The adjustable filter holder **30** at the rear of the sunshade has a vertical slide conveyor with

index stop for the operating position and is adjusted with the positioning knob **29**. The filter holder takes 75 x 75 mm (3" x 3") filters as well as 100 x 75 mm (4" x 3") graduated filters up to a thickness of 8 mm. If rectangular graduated filters of 100 x 75 mm (4" x 3") are to be used, the filter holder can be vertically adjusted to any position required and will remain at that setting of its own accord. A supplementary ARRI special filter mount with polarizing filter can be adjusted with a wheel to give the required setting of the polarizing filter.

We definitely recommend the use of a sunshade. In order to obtain the best shooting conditions (good contrast) in shots against or partially against the light, the adjustable sunshade with bellows should always be used. If needed, a mask **25** (also available as a special accessory especially for longer focal lengths) can be inserted into the front frame of the adjustable sunshade.

Magazines

The compact single-compartment type magazines used on the ARRIFLEX 35 II C have a built-in feed and take-up mechanism and are available as either 200 ft (60 m) types or 400 ft (120 m) types (the latter takes 400 ft (120 m) of colour or 500 ft (150 m) of black and white film).

After the lock **31** has been released, the lid of the 200 ft (60 m) or 400 (500) ft (120–150 m) V-R magazine can be completely detached. The footage indicator **32** and the two knurled disks for taking up film slack in the magazine **33** are located on the reverse side of the magazine.

The 400 (500) ft (120–150 m) magazine, unlike the 200 ft (60 m) magazine, is designed for forward and reverse running and automatically adjusts itself to the direction in which the camera is operating.

Motors

The motor **34** is attached to the camera by means of four screws and serves also as a grip for the operator's left hand. The rheostat control cap **35** and the socket for the power cable **36** protrude from the bottom of this combined handgrip and motor housing. A toggle switch **37** for continuous running and a push-button switch **38** for short quick takes are built into the motor housing. A further toggle switch for forward and reverse operation **39** is located above the socket for the power cable.

The following motors can be used with the ARRIFLEX 35 II C:

1. A special quick-starting handgrip motor with built-in rheostat for regulation of film speeds between 12 and 32 f. p. s while operated with a 16 V battery (Cat. No. 04-A) with a toggle switch for forward and reverse operation. If

no film speed higher than 24 f. p. s. is required, this motor can also be fed from a 12 V automobile battery.

2. A handgrip motor with centrifugal governor for 24 f. p. s. (Cat. No. 2205). This film speed is constant and cannot be changed (forwards only).
3. A handgrip motor as described in 2., but for 25 f. p. s. (Cat. No. 2206)
4. A synchronous motor for 220 V/50 cycles, single or three phase AC operation, with intermediate gear and base plate (see special instruction leaflet) Cat. No. 2616. For single-phase operation 220 V: power cable with two-pin plug and built-in blocking condenser for auxiliary phase. For three-phase operation 220 V: power cable with three-pin plug. (Special voltages upon request).
5. A synchronous motor as described in 4., but for 110 V/60 cycles. Cat. No. 2618 (see special instruction leaflet).
6. A single frame 24 V motor for time lapse work, also suitable for use on the animation table, complete with gear plate, power supply unit for 110/220 V AC and frame counter. Cat. No. 2207 (see special instruction leaflet).

II. Loading the camera

Loading of 200 ft (60 m) magazines

The operations described in the following text should first be practised in daylight with blank film until the operator is perfectly familiar with the entire procedure. This will greatly facilitate the loading of unexposed film in the dark-room or in a changing bag.

Notice: Only use film that is wound with the emulsion side inwards!

The scale of the footage indicator on the back of the 200 ft (60 m) magazine refers to normal black-and-white film. If colour film is used, the indicator is no longer accurate as colour film is somewhat thicker than black and white film and gives a reel of larger diameter. For this reason, never load more than 200 ft (60 m) of film into the 200 ft magazine.

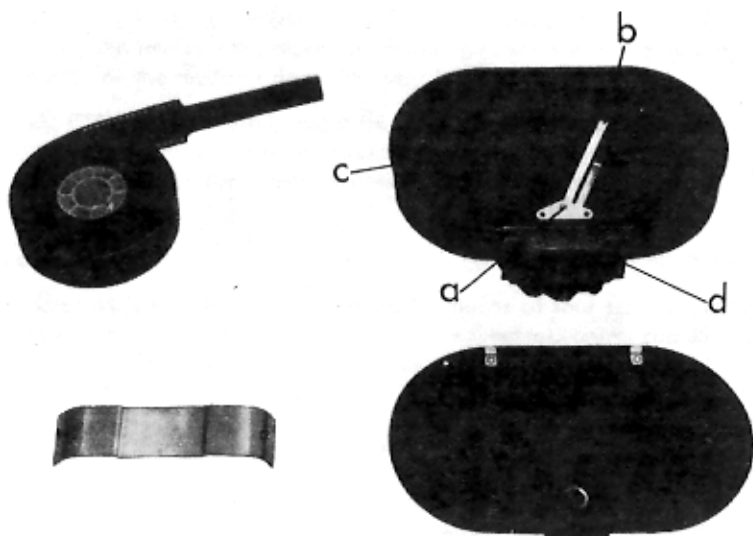

Fig. 2: Preparations for loading the magazine. Take note of the reference letters which appear in the following text.

To remove the lid of the magazine for loading, first press down the retaining spring and turn the lock **31** to the left. Then take hold of the lid by the projection above the lock, tilt it forwards and lift out of the two slots at the bottom.

Then place the magazine on the table (Fig. 2) with the mouth of the magazine facing towards you. Swing the tension roller **b** inside the magazine over to the right until it clicks home.

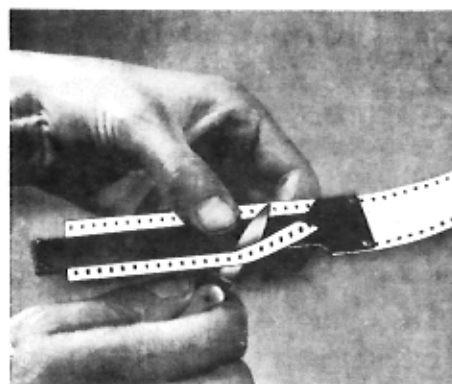

Fig. 3: Cut back the perforation to the twentieth hole with the template.

The roll of film to be loaded is then laid upon the table with the end of the film pointing towards the magazine and ready to be reeled off in a clockwise direction. Using the cutting templet supplied for this purpose, cut a leader up to approximately the twentieth hole as shown in Fig. 3, or at least cut open the first two holes of the perforation.

The trimmed film leader is then inserted into the feed sprocket **a** of the magazine from the inside until it emerges from the lefthand film channel (Fig. 4). In doing so, make sure that the film is inserted perfectly straight and parallel to the wall of the magazine so that the first two open holes of the perforation engage simultaneously with the sprocket. This can be facilitated by carefully turning the gear mechanism by hand. The roll of film is now slid onto the lefthand spindle **c**. If plastic cores with a groove are used, the spring on the spindle will snap in automatically with an audible click after a few turns of the knurled take-up disk **33**. If cores with a lug are used, however, care should be taken to see that the lug engages properly in the groove



Fig. 4: The film is passed through the feed sprocket parallel to the wall until it emerges through the left-hand channel.

of the spindle, as cores of this type do not engage automatically. The film roll must be perfectly flat and tightly wound upon its core. Deformed, odd-shaped rolls may not be used.

The end of the film is then pulled out to the left and laid round the outside of the magazine until the first perforation holes coincide with the marking rib. This ensures that the film loop is of the correct size, approximately 54 holes (Fig. 5). The trimmed leader is not counted in this measurement. If too much film is unwound in the process, the surplus should be carefully taken up again.

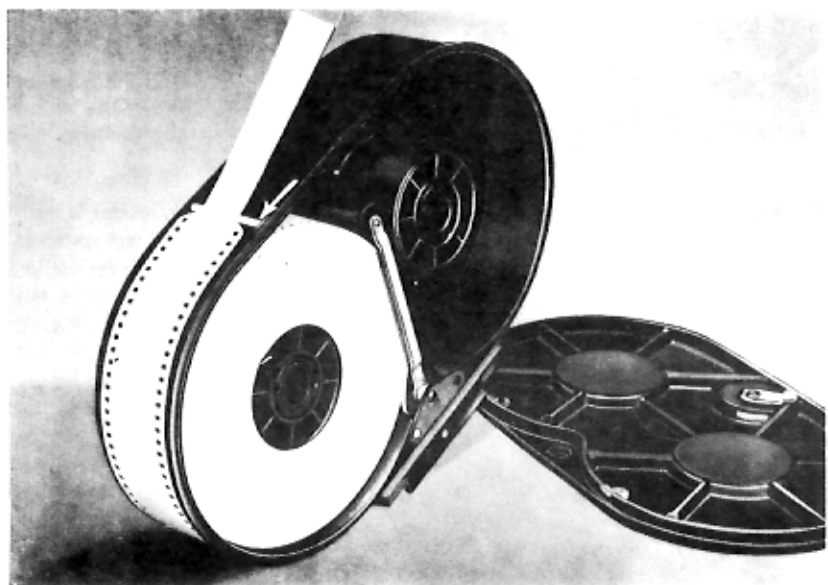

Fig. 5: The film leader is pulled out until the first trimmed holes coincide with the marking rib.

Without pulling any more film out of the magazine – if necessary, one or two fingers can be kept on the gear mechanism to keep it from turning – bend the end of the film back and insert it into the right hand film channel *d* of the magazine mouth to form a loop. The perforation should engage on both sides of the sprocket simultaneously. Now check to see that the emulsion side of the film loop is facing outwards. Pull the end of the film a short way into the magazine, taking care to see that the size of the loop remains unchanged and

that the gear mechanism runs smoothly, and release the tension roller by pressing it down to the right. Then swing it back to the left until it rests against the roll of film. (Fig. 6)



Fig. 6: This is how the properly loaded magazine looks!

The film leader is then fastened to the second plastic core with an adhesive tape or inserted into the slot on the core. Then the film is wound a few turns. After checking to see that the film is wound correctly, place the core upon the spindle on the take-up side in the same manner as the unexposed film roll, taking care that the core catches on the spindle (see page 11).

To close the magazine, the two half hinges on the magazine lid are inserted at an angle into the corresponding slots at the lower rim of the magazine (Fig. 7) and the lid is slowly and carefully shut. If the lid has been put on correctly, it should close without the use of force. As soon as the lid is properly closed it is secured by turning the lock **31** to the right.

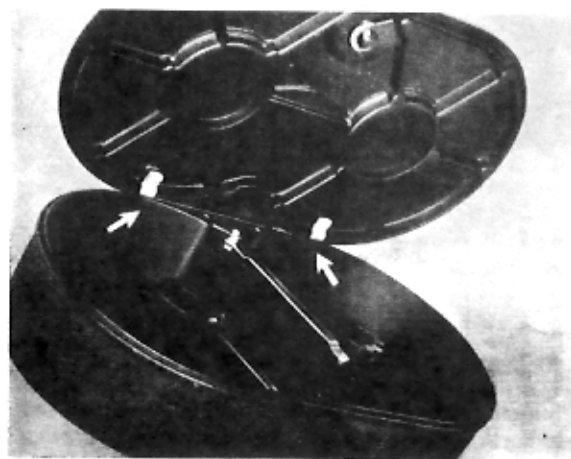

Fig. 7: If the two half hinges are inserted into the slots at the lower rim of the magazine housing correctly, the lid can be shut without the use of force.

Film loop guard

In order to avoid any possible damage to the film loop during transport, the use of the film loop guard is advisable. (Fig. 8) This accessory consists of a loose covering shield which is slid under a metal retaining plate attached to the mouth of the magazine.

The film loop guard is attached in the following manner: After the magazine has been loaded, press the film loop gently against the mouth of the magazine and slide the guard over the film and under the retaining plate. The film loop is now protected against kinking or other damage. Care should be taken to see that the guard is slid under the metal rim with the notch inwards.

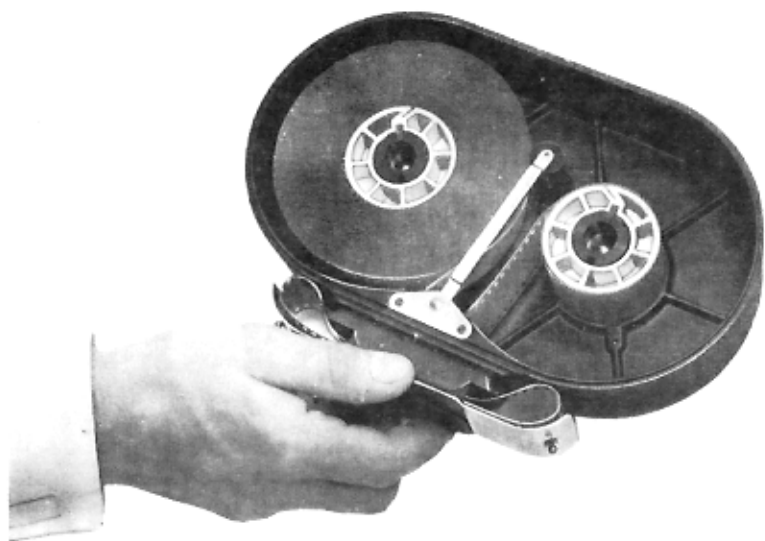

Fig. 8: The film loop guard helps to prevent kinks and other damage to the film.

Mounting the 200 ft (60 m) magazine upon the camera

Before mounting the magazine upon the camera it is advisable to remove the power supply cable from its socket in order to avoid any accidental starting of the camera which could cause damage to the film gate or claw mechanism.

Important!

The 200 ft (60 m) magazine for the ARRIFLEX 35 II C can only be used for running the camera forwards. Before turning on the handgrip motor, make certain that the toggle switch 39 is set at "V" position.

To mount the magazine, turn the lock 10 to position "A" and remove the camera door from the ARRIFLEX 35 II C. Before mounting the magazine, move the claw back as far as it will go with the manual control knob 4 and open the film gate. The magazine lock must also be opened by turning the knurled knob 15 to the left and pulling it out.

Now pass the film loop through the opening at the top of the ARRIFLEX 35 II C, apply the mouth of the magazine to the rear side of the dove-tail and push the magazine downwards. The driving gear of the magazine is now engaged with that of the camera. The exact meshing of the gears can be aided by carefully turning the control knob 4 which rotates the gears in the camera. It is very important that the film loop is not caught or jammed between the magazine and the camera while the magazine is being mounted, as a kink in the film might have difficulty in passing through the film gate. The magazine lock is now pressed home and tightened by turning it to the right. The magazine is now firmly attached to the camera.



Fig. 9: The correct path of the film from the magazine through the camera and back into the magazine.

Threading of film in the camera

The film is inserted in such a way that a loop is formed above the film gate. This should coincide as nearly as possible with the guide line in the camera. If the loop is too large or too small, the steadiness of the picture could be adversely affected. In order to be absolutely certain that the loop is of correct size, one can count off fifteen perforation holes between the mouth of the magazine and the uppermost point reached by the claw in its travel.

While threading the film, make certain that emulsion side is facing the lens. If this is not the case, the film on the feed roll is incorrectly wound. Now open the film gate and move back the claw with the control knob 4. Insert the film in the film gate and form a loop of the correct size by gently moving the film up and down with the middle and index fingers of the left hand. Before closing the film gate, adjust the claw to the perforation by means of the control knob 4 in order to prevent it from damaging the film perforation. After closing the film gate, the knurled knob is turned a few more times to check if the film transport is functioning properly.

The camera door is now replaced and secured by turning the lock to the right. The camera door is always replaced and detached parallel to the camera and not at an angle as with the magazine lid.

The use of the 400 ft V-R magazine is described in a special leaflet.

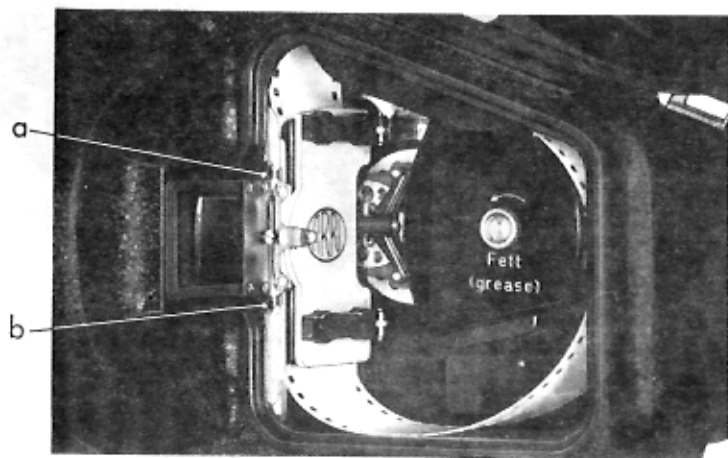

Fig. 10: While threading the film in the camera, make sure that the emulsion side of the film is facing the lens. a and b = film gate fastening strips (see page 26, no. 2).

III. Operation of the camera

How to hold the camera

Clasp the handgrip motor firmly with the left hand, leaving the thumb free to operate the toggle switch 37 or the push-button switch 38. With the right hand, take a firm hold on the bulge 1 containing the mirror reflex shutter. A special grip 2 is provided for the thumb of the right hand. The middle and index fingers of the right hand are left free to operate the focusing grips of the shooting lens.

With the camera securely held in both hands, press the rubber eyecup firmly against the eye to give the camera a three-point support. It is advisable to practise the correct holding of the camera until one has the feel of it. A neck strap can be attached to the two eyelets 8 and 16 as a precautionary measure when filming under difficult conditions.

Viewfinding and focusing

Whether the camera is running or still, the mirror reflex shutter of the ARRI-FLEX 35 II C gives a 6.5 x magnified viewfinder image that is free of parallax,



Fig. 11: For hand-held shots, the ARRI shoulder support (Cat. No. 2300) gives added stability and improves results considerably.

identical in focus with the film image, free of mirror effect and upright. When the camera is not running, however, viewfinding and focusing are only possible when the mirror reflex shutter is closed. This is done by turning the manual control knob 4.

Adjust the eyepiece to your eye by turning the diopter adjustment ring until the grain structure of the ground glass appears at maximum sharpness, then lock the setting with the locking ring. The rubber eyecup is turned until it fits the eye anatomically.

The shooting lens is focused by means of the focusing grips 20 which are manipulated with the middle and index fingers of the right hand. The lens is correctly focused when the viewfinder image appears sharp, as the ground glass and film images are identical in sharpness and format.

Under no circumstances should the mirror reflex system be tampered with, as it is impossible to readjust without special tools. Neither the ground glass frame nor the mirror reflex shutter may be dismantled.

In order to be able to focus clearly and with ease, the diaphragm should be fully opened. After the focusing is set, the diaphragm is stopped down to the desired f-setting before shooting. To simplify this procedure and to permit setting the diaphragm without removing the camera from the eye, the diaphragms of most lenses are equipped with click stops so that the f-setting can be made by counting the clicks. During action shots the focusing can be adjusted without an assistant even while the camera is in operation.

It is important that the eyecup be tightly held to the eye to prevent stray light from entering the camera through the viewfinder. If this is not possible during certain shots, close off the viewfinder tube by using the light sealing device 14.

Changing lenses

The three grips 18 on the lens turret enable the operator to change rapidly among three different lenses. The shooting lens clicks into place at the right-hand side of the camera near the shutter bulge. A code mark on the rear edge of the grip opposite the shooting lens and within the field of sight of the operator's left eye indicates the focal length of the shooting lens. With this, the operator can see what lens he is using without removing the camera from the eye. Provided that the lenses are mounted correctly, the grip with one dot represents the lens with the shortest focal length and the grip with three dots the longest.

If a rapid change of lenses is required in the middle of a scene, it is advisable to prefocus and preset the aperture of the following lens. Then the lens only needs to be brought into position by the turret grips.

An extensive selection of interchangeable lenses is available for the ARRIFLEX 35 II C. After the sunshade has been removed, these can quickly be exchanged with others in the turret by pressing together the two locking prisms 21 at the lens socket and lifting out the lens to be replaced. The new lens is carefully inserted so that the tongue in the socket engages in the groove of the lens mount.

When working with lenses with a focal length longer than 85 mm, it is advisable to use a special Arriflex tripod. If lenses of over 300 mm focal length are used, a lens supporting bracket is required because of the extra weight of such lenses (see also the special leaflet TI E 01 150 on ARRIFLEX lens supporting brackets). In this case, other lenses on the turret which interfere are removed and the empty sockets closed with the dust caps supplied for this purpose. These caps are always used if less than three lenses are mounted on the turret. For extreme close-ups, a lens extension tube (Cat. No. 2203) can be mounted between the turret and the lens. An even better solution is to use a macro lens which permits continuous focus from infinity to 4".

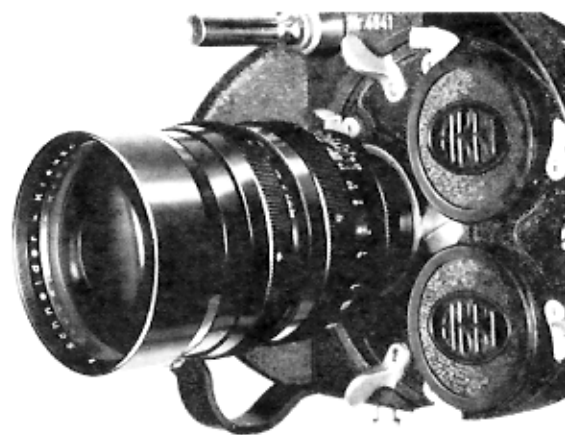

Fig. 12: If only one lens is mounted on the turret, the empty lens sockets must be covered by dust caps.

Setting the adjustable shutter

(This section only applies to the ARRIFLEX special model II C-BV)

The adjustable shutter of the special model ARRIFLEX 35 II C-BV enables exposure times to be shortened in order to catch fast moving objects, to counteract unusually strong light, or to reduce undesirable depth of field. It cannot, however, be adjusted while the camera is running and used for fading in and out. This can be done more easily and effectively in the printing laboratory.

The aperture of ARRIFLEX mirror reflex shutter can be reduced in stages of 15° from 165° to 0°. Each stage has a click stop. The various stages 15° - 30° - 45° - 60° - 75° - 90° - 105° - 120° - 135° - 150° - 165° can be read off through the socket of the shooting lens after the lens has been removed. The adjustable shutter can be adjusted in either direction.

After the shooting lens has been removed from its socket, turn the knurled adjusting knob as far as it will go in the direction of the arrow and press it in to adjust the adjustable shutter. This arrests the adjustable shutter blade and the correct aperture can then be set by turning the manual control knob.

Under no circumstances may the knurled adjusting knob (a) for the adjustable shutter be pressed in while the camera is running, nor may the camera be switched on with the knob pressed in.

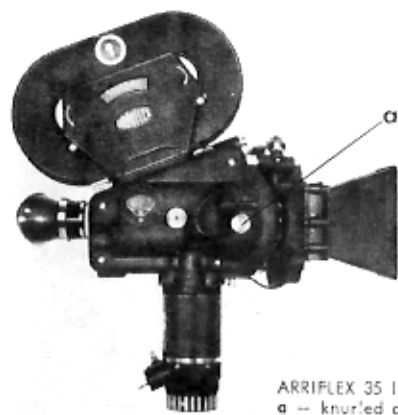

ARRIFLEX 35 II C-BV
a — knurled adjusting knob for the adjustable shutter

The knurled adjusting knob for the adjustable shutter is mounted on a spring to prevent possible damage to the shutter. It returns to its normal position upon being released, therefore it must be pressed in until the desired aperture has been set by turning the manual control knob 4 to left or right.

According to the colour of the edge of the mirror reflex shutter visible through the lens socket, the shutter opening can be read off in the outer scale (black) or the inner scale (red) (Fig. 13).

Particular care should be taken to see that the adjustable shutter clicks home in the required position, otherwise it might drift to an undesired setting while the camera is in operation.

The formula for finding the effective exposure time is as follows:

$$\text{Exposure time (in seconds)} = \frac{\text{Shutter opening (in degrees)}}{360 \times \text{Frames per second}}$$

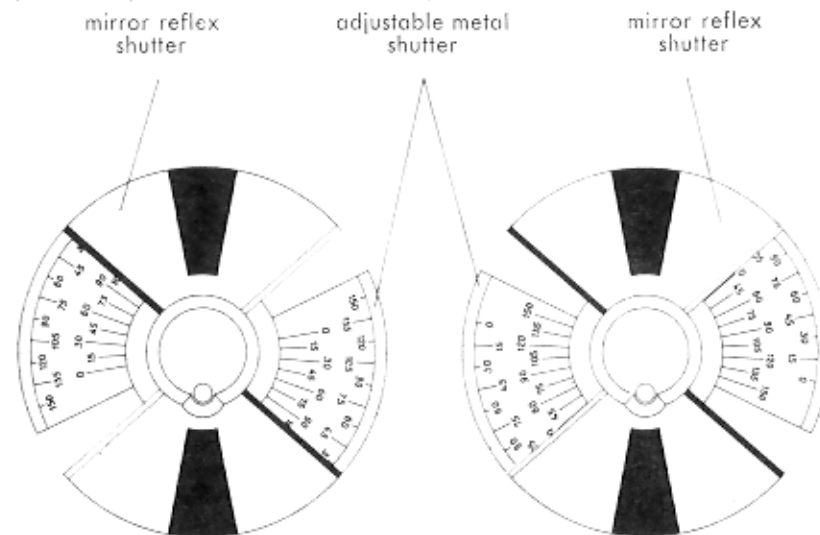

Fig. 13: According to the colour of the edge of the mirror reflex shutter segment visible through the lens socket, the angle of shutter opening can be read off from the outer scale (black) or the inner scale (red).

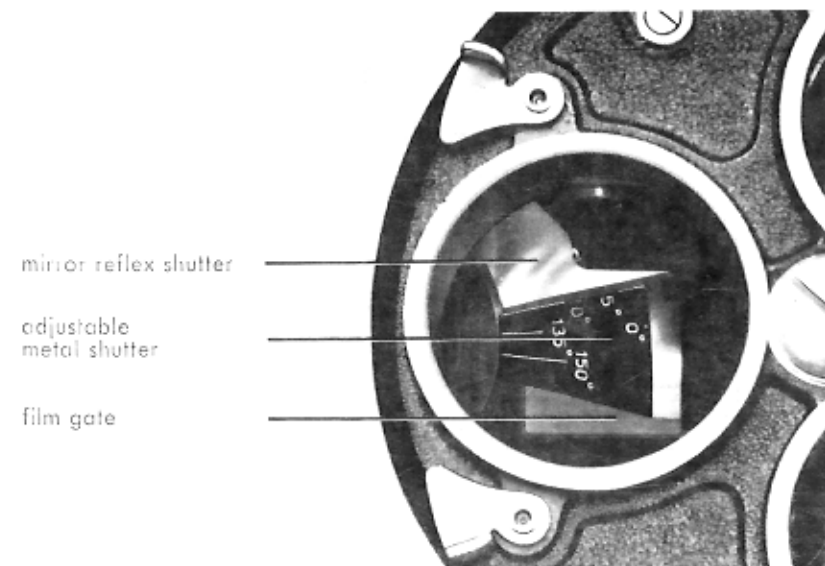

Fig. 14: This for instance is the setting for an aperture of 120.

Exposure times in seconds at various shutter openings for Arriflex 35 II C-BV camera

Frames per second	4	8	12	16	20	24	28	32	36	40	44	48
165°	1/9	1/17	1/26	1/35	1/44	1/52	1/61	1/70	1/78	1/87	1/96	1/105
150°	1/10	1/19	1/29	1/38	1/48	1/58	1/67	1/77	1/86	1/96	1/106	1/115
135°	1/11	1/21	1/32	1/43	1/53	1/64	1/75	1/85	1/96	1/107	1/117	1/128
120°	1/12	1/24	1/36	1/48	1/60	1/72	1/84	1/96	1/108	1/120	1/132	1/144
105°	1/14	1/27	1/41	1/55	1/69	1/82	1/96	1/110	1/123	1/137	1/151	1/165
90°	1/16	1/32	1/48	1/64	1/80	1/96	1/112	1/128	1/144	1/160	1/176	1/192
75°	1/19	1/38	1/58	1/77	1/96	1/115	1/134	1/154	1/173	1/192	1/211	1/230
60°	1/24	1/48	1/72	1/96	1/120	1/144	1/168	1/192	1/216	1/240	1/264	1/288
45°	1/32	1/64	1/96	1/128	1/160	1/192	1/224	1/256	1/288	1/320	1/352	1/384
30°	1/48	1/96	1/144	1/192	1/240	1/288	1/332	1/384	1/432	1/480	1/528	1/576
15°	1/96	1/192	1/288	1/384	1/480	1/576	1/664	1/768	1/864	1/960	1/1056	1/1152

Shutter opening in degrees

Starting the camera

First connect the ARRIFLEX 35 II C to the battery by means of the power cable, which is plugged into the socket **36** on the handgrip motor. Then adjust the rheostat control cap **35** to the required speed; this can be read off at the tachometer **6**. In order to waste as little film as possible, proceed as follows:

Set the approximate speed before threading the film. The difference in the running speeds of the camera with and without film is negligible. Immediately after mounting the magazine, set the camera in motion for a few seconds by pressing the push-button switch **38**; then adjust the rheostat control cap **35** to the desired speed with the aid of the tachometer. A red mark on the tachometer indicates the normal speed of 24 f. p. s. Approximately three feet (1 m) of film are required for this procedure.

When the filming is completed, turn the manual control knob **4** until the viewfinder image appears in the eyepiece again or until the red dot on the knob corresponds with its index mark. In this manner, the amount of stray light entering the camera by way of the lens and viewfinder while the camera is not running will be reduced to a minimum.

To ensure that the camera starts smoothly after long shooting pauses or if the camera has been transported, the two knurled disks on the rear side of the magazine should be turned in the direction of the arrows to take up any film slack in the magazine before the camera is turned on again.



Fig. 15: The large ARRI camera case (Cat. No. 2242) takes an ARRIFLEX 35 II C with mounted 400 ft (120 m) magazine, two spare 400 ft (120 m) magazines, a 200 ft (60 m) magazine, a shoulder support, filters and small accessories and is dust-proof and suitable for use in the tropics.

Storage and transport of the camera

The ARRIFLEX 35 II C should be transported and stored in the ARRI camera case specially designed for it. If the camera is transported loaded with film (especially if the camera is subject to vibrations in an automobile or other transport), it is advisable to arrest the film by engaging the claw in its perforation with the manual control knob. To do this, turn the knob until the engraved dot coincides with the mark on the camera housing. In this way it is impossible, even with severe jarring, for the upper and lower film loops to slip. Furthermore, the mirror reflex shutter remains closed in this position so that no light can fog the film.

After the camera has been transported, always take up the magazine slack by turning the knurled disks at the back of the magazine, as the film may have worked loose during transport. If this is not done, the film may not be taken up properly when the camera motor is switched on, and it could cause undesirable looping or even jamming.

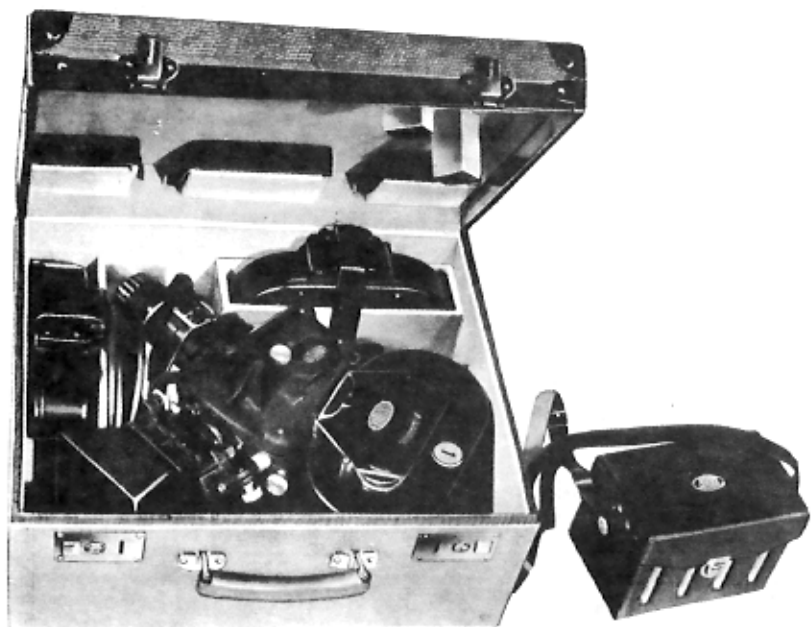
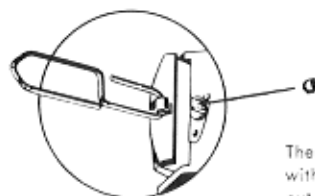

Fig. 16: The small ARRI camera case (Cat. No. 2241) takes an ARRIFLEX 35 II C with mounted 200 ft (60 m) magazine, three spare 200 ft (60 m) magazines together with filters and small accessories and is dust-proof and suitable for use in the tropics.

IV. Care and maintenance of the ARRIFLEX 35 II C

Changing the ground glass

The ground glasses are interchangeable. The shooting lens is lifted out and the locking screw is loosened with a screw driver. The ground glass can then be pulled out with the nail of the index finger or an opened-out paper clip. After a new ground glass has been inserted, the locking screw is tightened again (see illustration below).



The locking screw [a] on the ground glass frame is loosened with a screw driver by turning it counter-clockwise. An opened-out paper clip is hooked into the little handle of the ground glass and used to extract it from its frame.

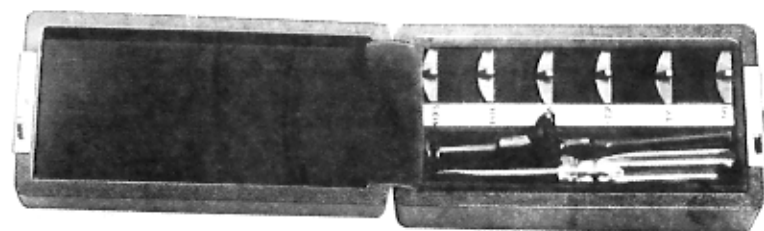

If extra ground glasses are ordered, they are available together with the tools for changing them in the above case.

Cleaning

Strict cleanliness is the first rule to be observed in the care and maintenance of any optical or mechanical precision equipment; this applies especially to the ARRIFLEX 35 II C. Film emulsion dust and film chips should be removed

from the camera interior with a soft hair brush to prevent their getting into the camera works. Check to see that the film gate is clean after each magazine change. It is almost impossible for an emulsion deposit to settle on the hard chrome surface of the film gate. Should it occur with film that has a very fresh emulsion, remove the deposit with a small sliver of soft wood or plastic. Under no circumstances may sharp utensils be used.

The film gate may only be removed for thorough cleaning by qualified repairmen. The following rules should be observed: The film gate should only be removed if absolutely necessary; next to the claw mechanism, it is the most delicate part of the camera. Perfect picture quality can only be maintained so long as the film gate remains absolutely plane. Never use force on the film gate! If absolutely necessary, the dismounting of the film gate should only be carried out by trained camera repairmen.

The film gate is removed as follows:

1. The manual control knob 4 is turned until the claw is drawn back to its centre position.
2. Loosen but do not remove the screws at the viewfinder opening and draw back the small strips underneath, then tighten the screws again. (see Fig. 10 on page 16)
3. Take hold of the film gate at its lock, swing it back to loosen it and then lift it out carefully (Do not use force!). Take care to see that the claw is drawn back to its centre position and that its point does not protrude through the slot in the film gate.
4. To reinstall the film gate, proceed in the reverse order, making certain that the camera surface of the film gate is clean. Then push back the retaining strips and tighten the screws. After assembly the rear focus must again be exactly 52 mm $\pm 0/-0.02$ mm.

Because of the danger of oxidation, the surfaces of the mirrors and lenses must not be touched with the fingers. Fingerprints which, in spite of this, do get on to these parts must be immediately and thoroughly removed to avoid the possibility of oxidation. The lens coating protects the lens surfaces to a large degree against outside influences, but only so long as it remains undamaged.

The cleaning of optical surfaces should be carried out with care according to the following rules:

Dust particles are usually removed with a soft hair brush or a rubber bulb, never by blowing with the mouth. Stubborn dust particles, fingerprints, and smears are removed with a soft, dry, lint-free linen rag which has been washed several times. The lens cleaning tissue of well-known manufacturers that is widely

used today can well be recommended for this purpose. As chemical solvents tend to dissolve the sensitive lens coating, the linen rag may be dampened with chemically pure benzine or gasoline to clean especially dirty surfaces.

The above-mentioned hair brush should be cleaned in chemically pure benzine or gasoline and then shaken until dry. It should not be touched again with the fingers before it is used. A brush cleaned in this manner guarantees that the lenses can be cleaned without smearing.

The front lenses of zoom and retrofocus lenses are to be kept especially clean, as foreign particles on them could enter into the picture when the lenses are stopped down sharply. This also applies to filters and plane glasses (also when working with blimps), but it is especially pertinent to the above-mentioned lenses. Strict observance of the rules already given will have a positive effect on picture quality.

The cleaning of the mirror reflex shutter, ground glass and the entire viewfinder system, however, has no effect upon the picture itself. For this reason, these parts – especially the mirror reflex shutter – should not be cleaned more than absolutely necessary to avoid possible damage to them.

The interchangeable ground glasses are usually cleaned between the fingers with soap foam, rinsed, and then dried.

We seriously warn against taking lenses apart for cleaning. Lenses which have become defective, and especially those with dirty interior surfaces, should be sent to the factory. From time to time the lens casings should be cleaned and lightly lubricated at the mount. This helps prevent friction between the lens mount and the turret socket which could make focusing more difficult.

Lubrication

The ARRIFLEX 35 II C has only a few lubrication points. These should be attended to every two to three months or after every fifteen to twenty thousand feet (5000 to 6000 metres), according to the amount of use made of the camera. In order to gain access to these lubrication points, unscrew the manual control knob and remove the gear cover. First apply grease to the lubrication point inside the camera to the right of the plate indicating the loop size. Then use oil for the two holes visible at the centre of the claw mechanism to lubricate the shaft. The hard fibre claw guide at the eccentric is lubricated lightly with grease.

Only the special oil and grease supplied with the camera should be used for lubrication. Both are frost-resistant down to -22° F. (-30° C.). In emergencies thin spindle oil can be used. A single drop is sufficient. **Do not lubricate too often! This could cause oil splashes or fine oil vapour to settle upon the lens, especially if the teeth of the gears are oiled, which is totally unnecessary.**

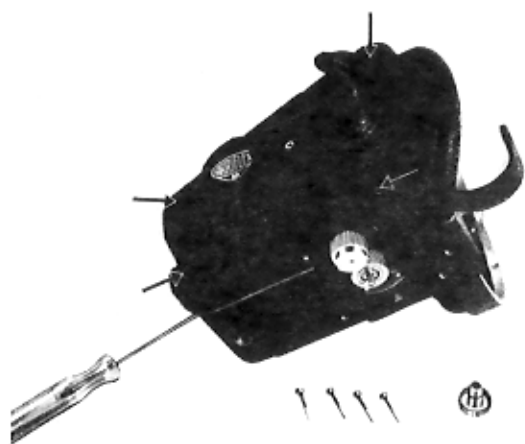

Fig. 17: The gear cover can be removed for cleaning by carefully raising it with a knife or screwdriver.

In order to open the camera gear mechanism for cleaning and lubrication, the gear cover on the right-hand side of the camera must be removed. To avoid damaging the sensitive glass mirror reflex shutter, observe the following directions carefully:

The four countersunk screws attaching the screws holding the four corners of the gear cover and the two handgrip motor are removed. The manual control knob 4 is unscrewed and the gear cover lifted near the tachometer 6. If the cover is seated too

tightly, carefully use a knife or screwdriver to lift it, (see Fig. 17).

After the lid has been lifted so that it slips over the driving shaft, it is tilted forwards at a 45° angle in the direction of the shutter bulge (Fig. 18). Before lifting the cover, make certain that the shutter is at its open position.

The camera mechanism can now be cleaned and lubricated. Under no circumstances may the mirror reflex shutter and its bearing be dismantled, as this is precision mounted for absolutely smooth operation. Lubrication of the shutter bearing is unnecessary. The built-in ball bearings cannot be dismantled without special equipment.

The sliding surfaces and ball bearings are to be lubricated with the special ARRIFLEX grease supplied in tubes for this purpose, and which is frost-resistant down to - 22° F (- 30° C.).

A general lubrication will not be necessary for a considerable length of time, as almost the entire camera mechanism runs on ball bearings. It will only be required when the original factory lubrication has been used up. Of course it is impossible to set down any fast rule, but after about 60 to 75 thousand feet of film have been run through the camera or a maximum of three to four years after the camera was purchased, it is advisable to have the entire camera lubricated at the factory.



Fig. 18: After lifting the gear cover so that it slides over the driving shaft, tilt it forwards at a 45° angle towards the shutter bulge and lift it off.

Magazines manufactured before 1962 have one lubrication point on the bearing of the magazine drive at the centre of the bearing pin. As the magazine drive is subject to relatively heavy strain, especially in large magazines, it is recommended that this point be lubricated frequently, i. e. after about ten loadings. The teeth of the gears are not to be lubricated. Magazines manufactured since 1962 have a ball bearing mounted magazine drive which is only to be lubricated as a part of the general lubrication.

These directions should serve as a guide for normal usage. After expeditions to tropical or polar regions, or to areas where the camera came into contact with fine beach or desert sand, the ARRIFLEX 35 II C should be sent to the factory or an authorized repair shop for a thorough cleaning and lubrication.

V. Possible troubles and their correction

If you have studied this manual carefully and practised operating the camera and magazine with blank film, it is hardly possible that problems will arise during operation of your ARRIFLEX 35 II C. The usual cause of problems is incorrect handling and this can be quickly remedied.

Unsteady pictures

Unsteady pictures are usually caused by incorrect threading. The loops above and below the film gate are too large or too small, or the emulsion of the film is too fresh and leaves deposits at the film gate, thus causing an unsteady picture.

Remedy: Adhere strictly to the loop size indicated in the camera and be sure magazine leader is of the correct length by using the marking in the magazine.

Film of less than 34.7 mm width (standard size 35 mm) can cause lateral unsteadiness. The side pressure rail of the film gate compensates for variances down to 34.7 mm.

Remedy: Never use film of less than 34.7 mm width.

If the camera has been in operation for a long period of time, it is possible that emulsion particles may get under and impede the movement of the spring-cushioned rail. The stationary side rail may also be worn down. Both could cause an unsteady picture.

Remedy: Remove the emulsion particles with a blunt sliver of soft wood. If the side rail is worn it must be sent in for repair. This also applies if the claw has been worn out after many years of use. To reduce wear on the claw, keep it lubricated as directed.

If the cause of the unsteady picture cannot be explained, we recommend taking a double exposure which will indicate whether the claw mechanism is in need of repair or if film with an improper perforation size is being used. If the double exposed pictures do not run into each other, the claw mechanism is in order. The double exposure is only effective, however, when the claw engages in the same perforation hole at the beginning of both exposures and the camera is run in the same direction.

Emulsion deposits at the film gate

Remedy: If the emulsion of the film used is too fresh, experience has

shown that the film gate must be cleaned often to remove emulsion deposits. For this reason, use only film which has been stored for the proper length of time to allow the emulsion to harden.

Scratched film

If the emulsion of the film used is too fresh, it is possible that film deposits forming at the film gate may cause scratches on the emulsion side of the film as well as an unsteady picture.

Remedy: Check the film gate after each magazine loading and remove any deposits with a blunt sliver of soft wood or plastic.

Scratches on the back surface of the film can only result from a damaged pressure plate.

Remedy: Always treat the rear pressure plate with care and never clean with a hard object.

If the hard chrome plating of the film gate or the rear pressure plate has been damaged by rough treatment, scratches may result on both sides of the film.

Remedy: Send the camera in for repair.

In order to find out if film scratches are caused by the camera or the magazine, mount a magazine of new film on the camera in the usual manner and run about 15 ft (5 m) through the camera. Then cut the film just above the film gate and just before it re-enters the magazine. Check the piece of film coming directly from the magazine first, then the strip which has passed through the film gate, and finally, that which has been taken-up again in the magazine. In this manner, one can quickly pinpoint the source of trouble.

For scratches caused by the mouth of the magazine, see the instruction booklet for the 400 ft (120 m) V-R magazine, page 16. Cleaning of the magazine mouth.

Fogging

The eye was not held tightly enough against the rubber eyecup and stray light was able to enter the camera to affect the film.

Remedy: To prevent stray light from entering, make sure that the rubber eyecup fits snugly at the eye. This is especially important if strong light is coming from the rear.

Stray light has entered the camera through the eyepiece while filming without the viewfinder.

Remedy: During shots without the viewfinder, close off the viewfinder tube with the lever 14 if a viewfinder eyepiece without an automatic closure mechanism is mounted on the camera.

The camera was left standing for a considerable length of time with the mirror reflex shutter open.

Remedy: Close the mirror reflex shutter with the manual control knob at the end of each shot. The shutter is closed when the viewfinder image is visible.

While working without a sunshade, light has entered through the two extra lenses on the turret.

Remedy: Always work with a sunshade. If this is not possible while using a lens of longer focal length, close the lens sockets with the dust caps supplied for this purpose.

Loaded magazines were left under strong light for a considerable length of time before being mounted upon the camera.

Remedy: Always keep loaded magazines in the case when not in use.

Lack of brilliance or poor definition

The surface of the shooting lens has been touched with the fingers, leaving fingerprints.

Remedy: Do not touch the lens surface with the fingers. Should this occur by accident, clean the lens surfaces as described in the section „Care and maintenance“.

While filming against the light with a lens of longer focal length, the sunshade was used without a mask.

Remedy: While shooting at an oblique angle to, or directly against the light, it is absolutely essential that the mask designed for use with lenses of 50 mm and 75 mm focal length be attached to the sunshade.

For the adjustable sunshade with bellows usually used for such shots, only one mask is available, as the length of the bellows is adjustable.

Important: While extending the bellows, make certain that the film image itself is not masked smaller. This can be controlled through the viewfinder.

Imperfect filters were used while shooting with lenses of long focal lengths.

Remedy: Only use filters which are free of imperfections. Imperfect filters affect picture quality more with lenses of long focal lengths than with those of short focal lengths. A filter of sufficient quality for use with the latter is not necessarily good enough for use with longer focal lengths. A lot depends upon the quality of the optical surfaces. For the cleanliness of filter surfaces, the directions in the section „Care and maintenance“ should be observed.

A lens of long focal length was used with a sunshade that was too short.

Remedy: Always use a sunshade of sufficient length when shooting with lenses of long focal lengths.

Unusual circumstances have caused the distance between the lens flange and the film plane to increase. The end of a film, doubled over several times, might have jammed in the film gate, thus pulling it out of alignment.

Remedy: Have the film gate removed and its mounting repaired by a competent repairman as described in the section „Care and maintenance“.

Film Jamming

The film became detached from the take-up core before it was wound up.

Remedy: Fasten the film to the take-up core of the 200 ft (60 m) magazine with tape. Follow the printed directions for fastening the film core to the expansion core in the 400 ft (120 m) V-R magazine.

The take-up friction has decreased due to gradual stretching of the spindle drive cord so that the magazine winds slowly or not at all.

Remedy: Remove the cover at the back of the magazine by loosening the two screws. Then move the tension spring in the saw teeth towards the mouth of the magazine.

The mouth of the magazine jams. As the result of incorrect handling, shreds of film are blocking it.

Remedy: Unscrew the cover of the magazine mouth and carefully remove the shredded film (see the printed instructions for the 400 ft (120 m) V-R magazine, page 16).

The plastic core reduces the take-up friction. Plastic cores which fit too tightly on the spindle can, if not properly centered, reduce the take-up friction by rubbing against the rear wall of the magazine or inside the lid.

Remedy: Cores which are too tight should not be used. Cores should never fit too tightly, nor should they have more than 0.5 mm play on the spindle.

The claw is not transporting the film properly. The claw mechanism may be worn out.

Remedy: The camera must be sent in to the factory or an authorized repair shop for repair.

The film perforations have been damaged by the claw. The manual control knob is protected to a great degree against accidental blows by two projecting guards. It is possible, however, that the driving shaft could be forced out of its position if the manual control knob becomes loosened, and that this could shove the claw away from its normal pattern of movement.

Remedy: By pressing upon the curve of the claw, push the shaft back into its normal position and tighten the manual control knob properly with the screw and counter-nut.

Irregular running

Moulded plastic cores supplied with the film have either too large a slot or too large a hole, with the result that they slip over the transport catch and only engage after the core has made another turn.

Remedy: Always use cores that are free from imperfections and which have at the most 0.5 mm play on the spindle. A thin piece of cardboard can also be used to secure the core.

Camera runs too slowly, irregularly, or not at all

The terminals of the battery are oxidized or have worked loose.

Remedy: Clean and, if necessary, tighten the terminals. Then grease them tightly with vaseline.

The battery charge is too low. On lead acid batteries this can be seen by the sinking balls. As the cells of the battery are connected in series, a fall in the charge of a single cell is sufficient to affect the charge of the entire battery. Each cell has three balls and the more of them sink, the lower the charge.

Remedy: Recharge battery. Fill up, if necessary, with distilled water, or check acid density (see instructions for use of Arri batteries).

The battery is worn out. This possibility must be taken into account if the battery is more than two years old or if it has been left uncharged for a long time or otherwise badly treated (short circuits, etc.).

Remedy: Never leave lead acid batteries uncharged for any length of time. Even if not in use, recharge every three weeks. Replace worn out battery.

If the battery is in order and the camera will not run, it is possible that the cable is faulty.

Remedy: Check the voltage at the camera end of the cable with a voltmeter. If there is no current, the cable is broken and must be replaced.

The push-button switch functions, but the toggle switch does not.

Remedy: The toggle-switch is broken and must be replaced.

The rheostat or perhaps the motor may have been damaged by applying too high a voltage (more than 16 V).

Remedy: Have the rheostat control cap removed in a competent repair shop by removing the countersunk screws round the outside, and have the rheostat and motor tested.

If the camera will not run at the required speed in very cold weather, it has not been lubricated with the special oil and grease supplied for the purpose. A further reason for losing speed in very cold weather is the drop in voltage and capacity of the battery.

Remedy: It is advisable to clean the bearings of the camera and relubricate them. However, they should only be lubricated with the oil and grease supplied for this purpose. During very cold weather, use a battery of higher capacity.

Film end jams in film gate or magazine mouth

With raw film bought in bulk and spooled into smaller rolls the end of the film is sometimes bent over several times to fasten it to the core. When such film ends become jammed in the magazine mouth or the film gate, the camera comes to an abrupt stop (switch off camera immediately).

Remedy: Film should never be attached to the core in this manner. It is very important that it should be properly attached.

Film jams in film gate. It is possible that the end of the film, if doubled over several times, could pull the film gate out of alignment.

Remedy: As above.

Film end jams in magazine mouth.

Remedy: Unscrew lid of magazine mouth and clean magazine mouth (see printed instructions for the 400 ft (120 m) V-R magazine, page 16).

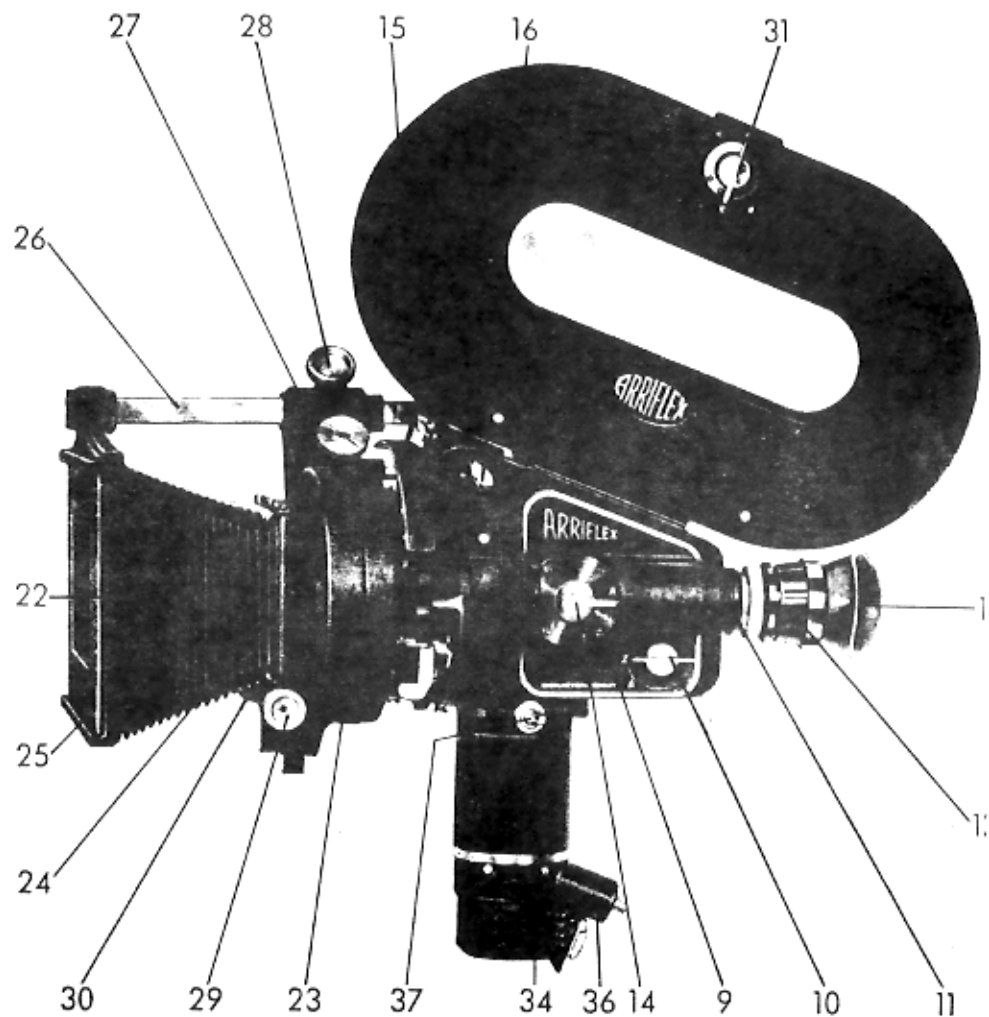

- | | |
|---|---|
| 9 Camera door | 24 Leather sunshade bellows |
| 10 Lock to camera door | 25 Mask |
| 11 Viewfinder tube with knurled ring | 26 Sunshade boom |
| 12 Eyecup | 27 Clamp |
| 13 Viewfinder eyepiece with diopter adjustment and locking ring | 28 Knurled locking screw |
| 14 Lever for closing off the viewfinder tube from the inside | 29 Positioning knob |
| 15 Magazine lock | 30 Filter holder |
| 16 Eyelet for neck strap | 31 Magazine cover lock |
| 22 Adjustable sunshade with bellows | 34 Handgrip motor (governor controlled) |
| 23 Lens cover | 36 Socket for power cable |
| | 37 Toggle switch of handgrip motor |

Reverse side: Rear view of ARRIFLEX 35 II C

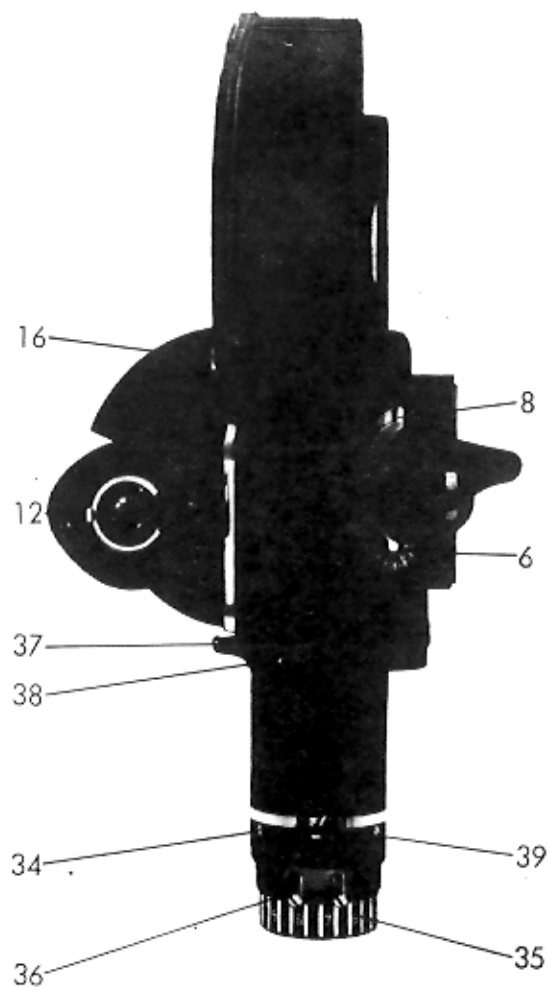

- | | |
|--------------------------|--|
| 6 Tachometer | 36 Socket for power cable |
| 8 Eyelet for neck strap | 37 Toggle switch with projecting guards |
| 12 Eyecup | 38 Push-button switch |
| 16 Eyelet for neck strap | 39 Toggle switch for forward and reverse operation |
| 34 Hand grip motor | |
| 35 Rheostat control cap | |